

19013376

KIT BOMBA DESAGÜE EVO AF (S500) & LVS (S300 - S400)

Nº	REF	DESCRIPCION	CANT.
1	12023666	MANGUERA DESAGÜE	1
2	12041924	CONDUCTO CUBETA-BOMBA DESAGÜE	1
3	12009986	ABRAZADERA SINFIN DIN 3017 W2 32-50L	2
4	12094265	MOTOBOMBA 220V AC 1N 50/60HZ 37KW UL	1
5	12010021	JUNTA GUIA	1
6	12010023	ABRAZADERA 2032 INOX	1
7	12114815	ALIVIADERO VERSION BD	1
8	12115850	JUNTA TORICA Ø32 X 3,5MM	1
10	12094016	CONDUCTO ASPIRACION LVS BOMBA DESAGUE HA	1
11	12115815	ALIVIADERO_EVCO-21_B	1
12	12104085	JUNTA TOR. DIAM. INT. 19,2X3	1
13	12000647	EMBALAJE DE CARTON 260X260X260	1
14	12126010	MANUAL DE INSTRUCCIONES	1

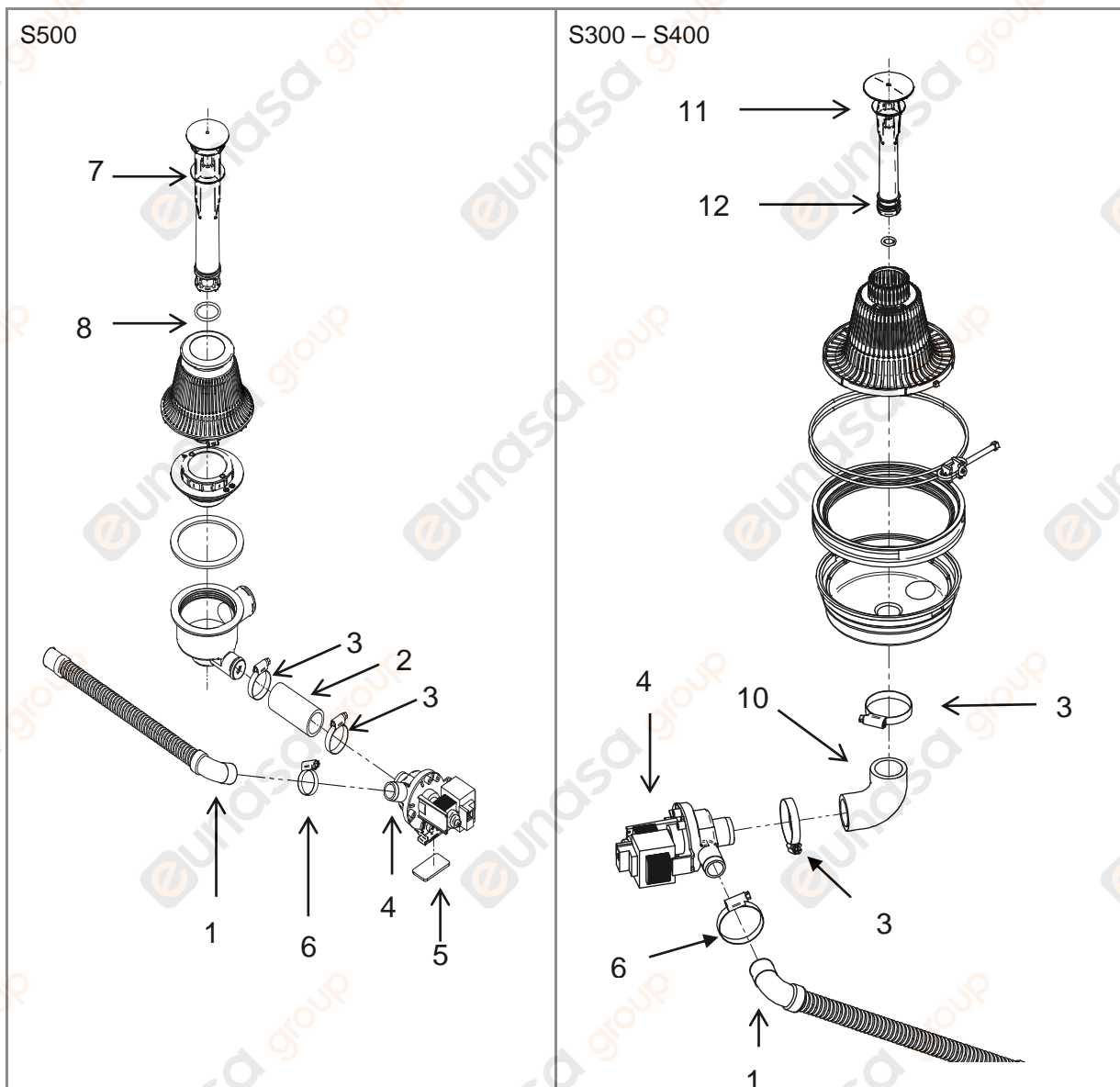

IMÁGENES



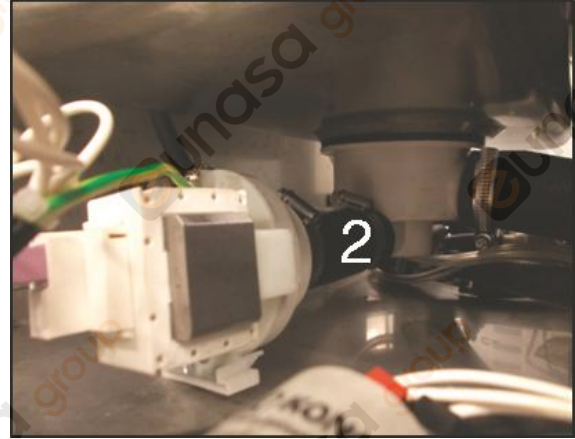
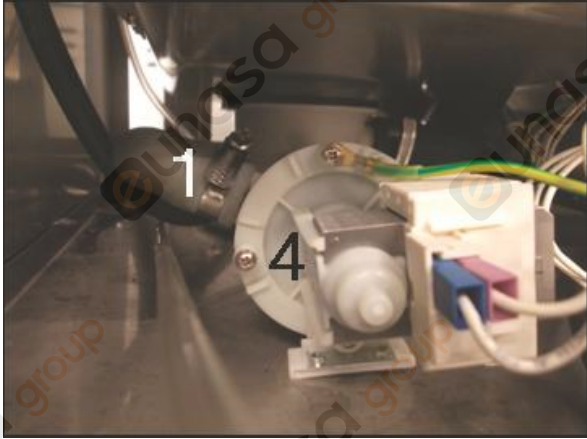

S500

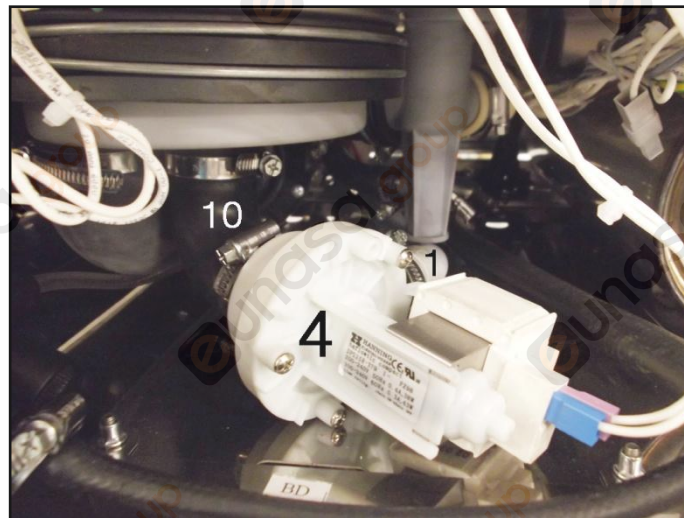

S300 - S400

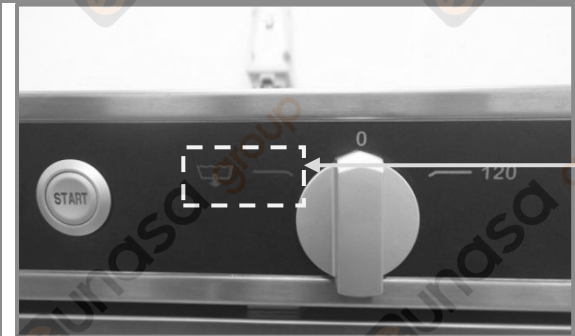

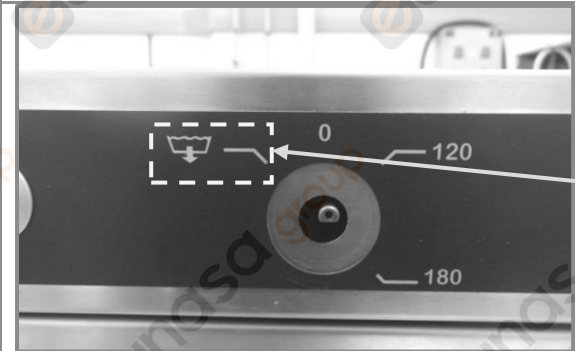
EJECUCIÓN

	<p>El postizo ciega la prestación de desagüe.</p>
	<p>Extraer el botón de mando.</p>
	<p>Extraer el postizo.</p>
	<p>Al extraer el postizo, la prestación de desagüe se hace visible.</p>
	<p>Montar de nuevo el botón de mando.</p>